

THIRD ANGLE PROJECTION

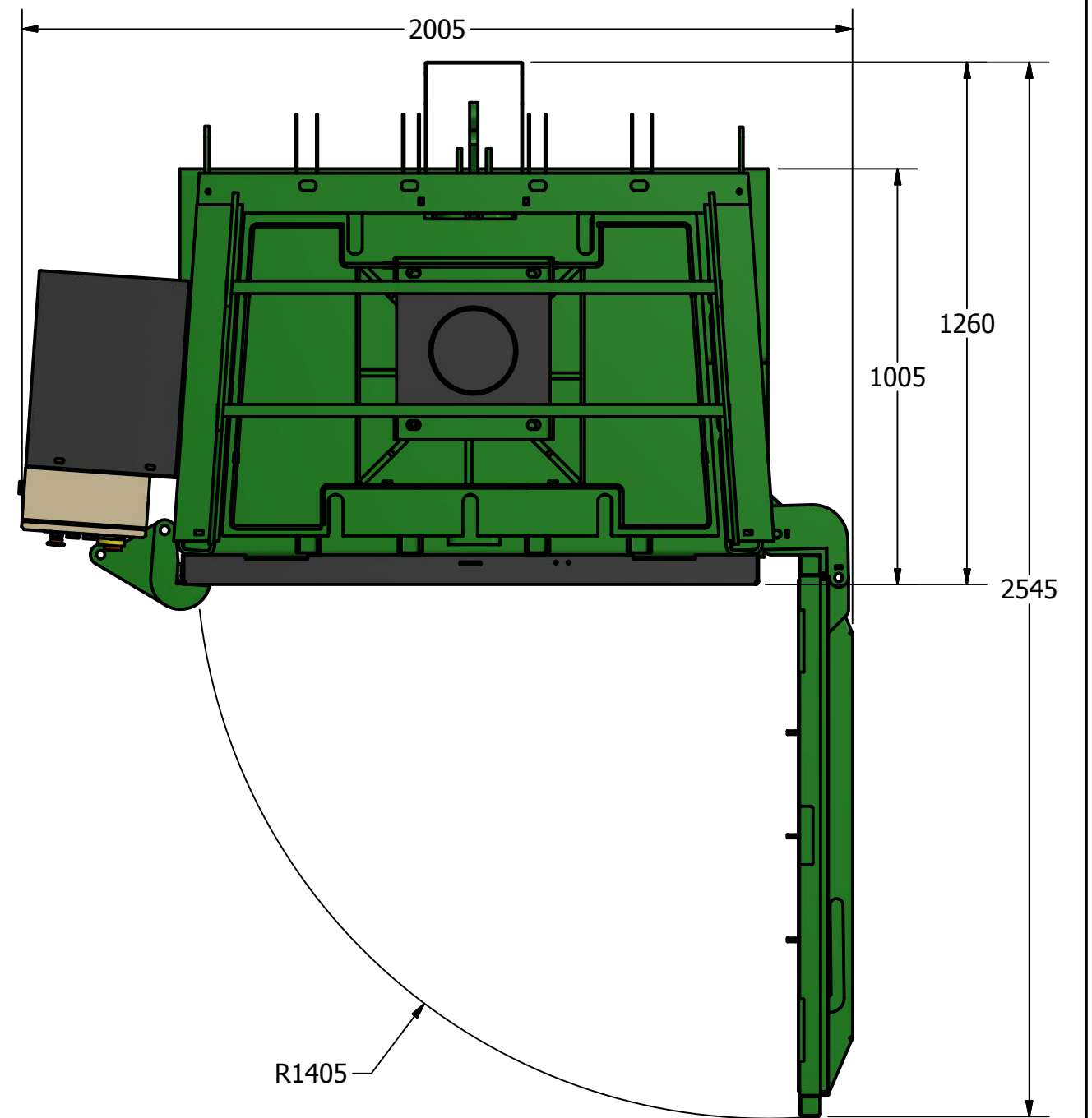
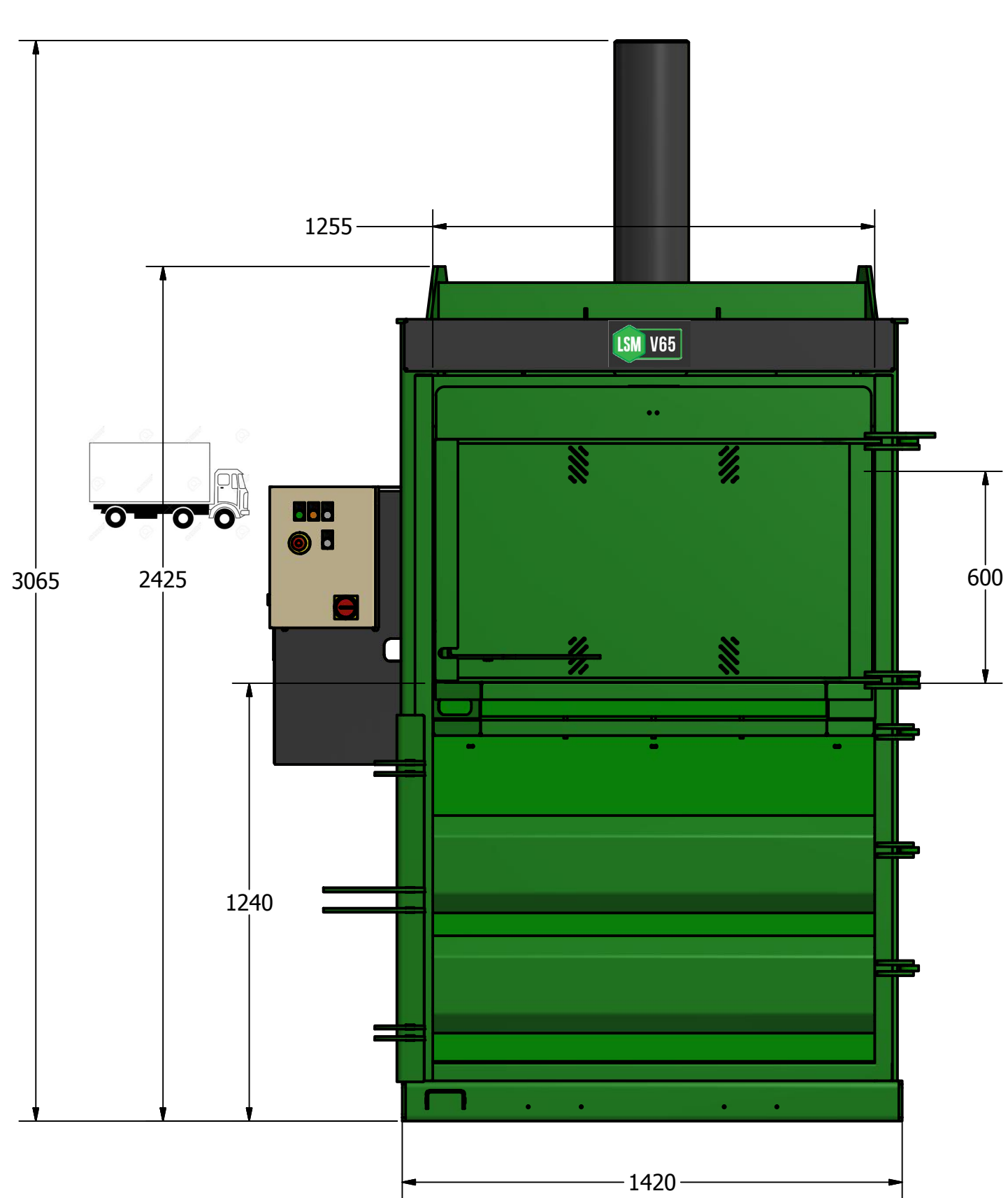
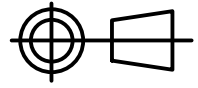

WWW.LSMLTD.COM

MODEL CODE	V65
MACHINE WEIGHT	2,840 Kg
NOISE LEVEL	76 dB